

# CERATIZIT GROUP

ИНСТРУМЕНТИ ЗА БЪДЕЩЕТО





**CERATIZIT**

**Вашият успех е наш  
основен приоритет.**



# Кои сме ние?

CERATIZIT е високотехнологична, инженерингова група, специализирана в производството на режещи инструменти, твърди сплави и технологии свързани с тях.



# Повече от 100 години експертен опит: Сливане на двама пионери в областта на твърдите сплави

**CERAMETAL**, основан в Берелданге (Люксембург)



**Metallwerk Plansee**, основан в Ройте (Австрия)



1921

1931

2002

**100** YEARS **CERATIZIT**  
Tooling the past, present & future

**CERAMETAL**

Plansee **TIZIT**

Обединяват се в CERATIZIT-Gruppe



# \ Повече от 100 години експертен опит: Стратегически и динамичен растеж

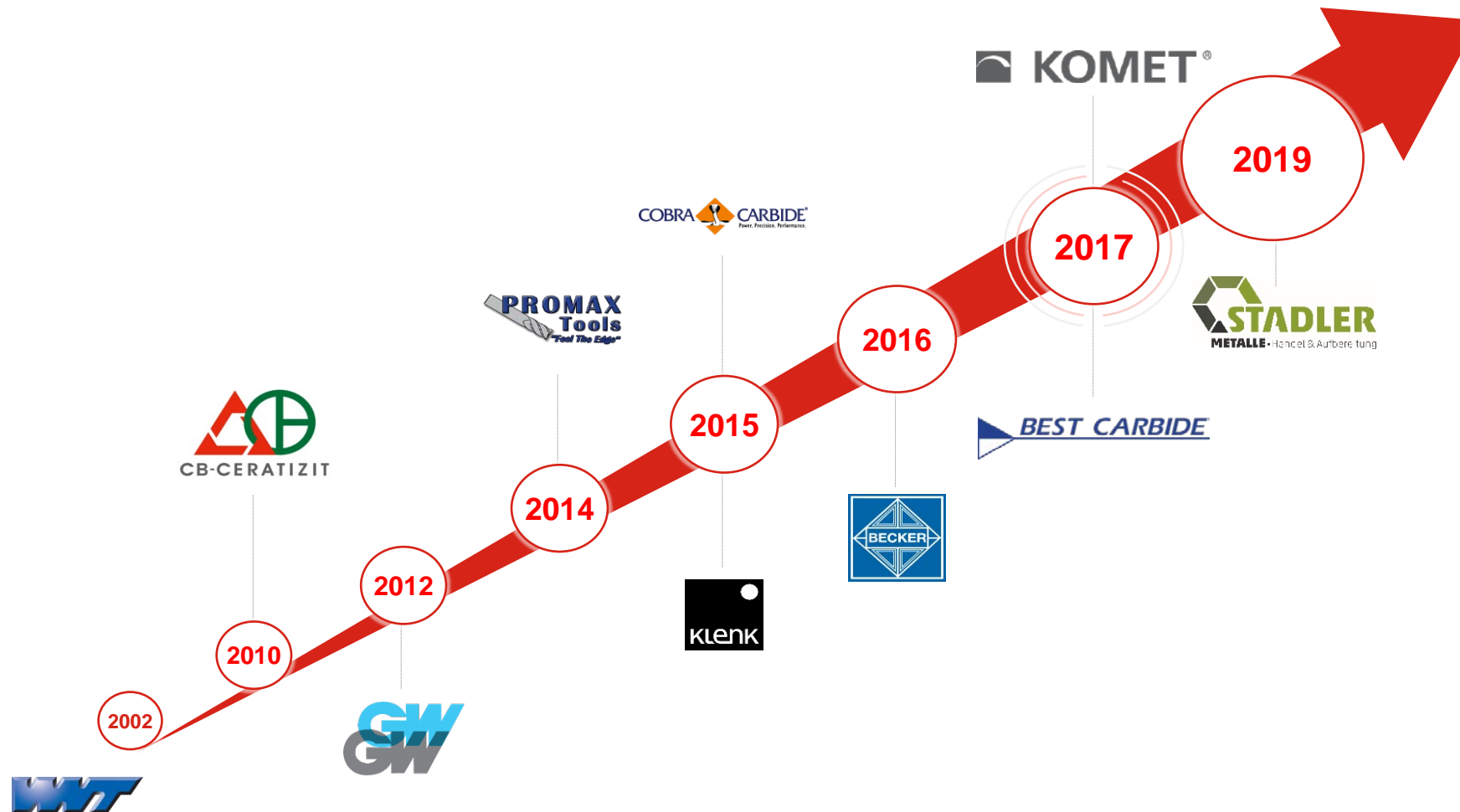

# \ Глобален играч: производствени и търговски единици





## Седалище

Mamer, Luxembourg



**25** Повече от  
производствени  
фирми



**35** 30% от продуктите  
са изработени  
през последните  
5 години



**200** Повече от  
служители в отделите по  
научноизследователска и  
развойна дейност



**80** Повече от  
държави, в които  
сме активни



**8000** Повече от  
служители



**15** Повече от  
награди за  
иновации



**1000** Повече от  
патента и полезни модели



**100 000** Повече от  
продукта



**1** МЛРД оборот.



# \ Оборот по пазари: Продажби през 2019 г

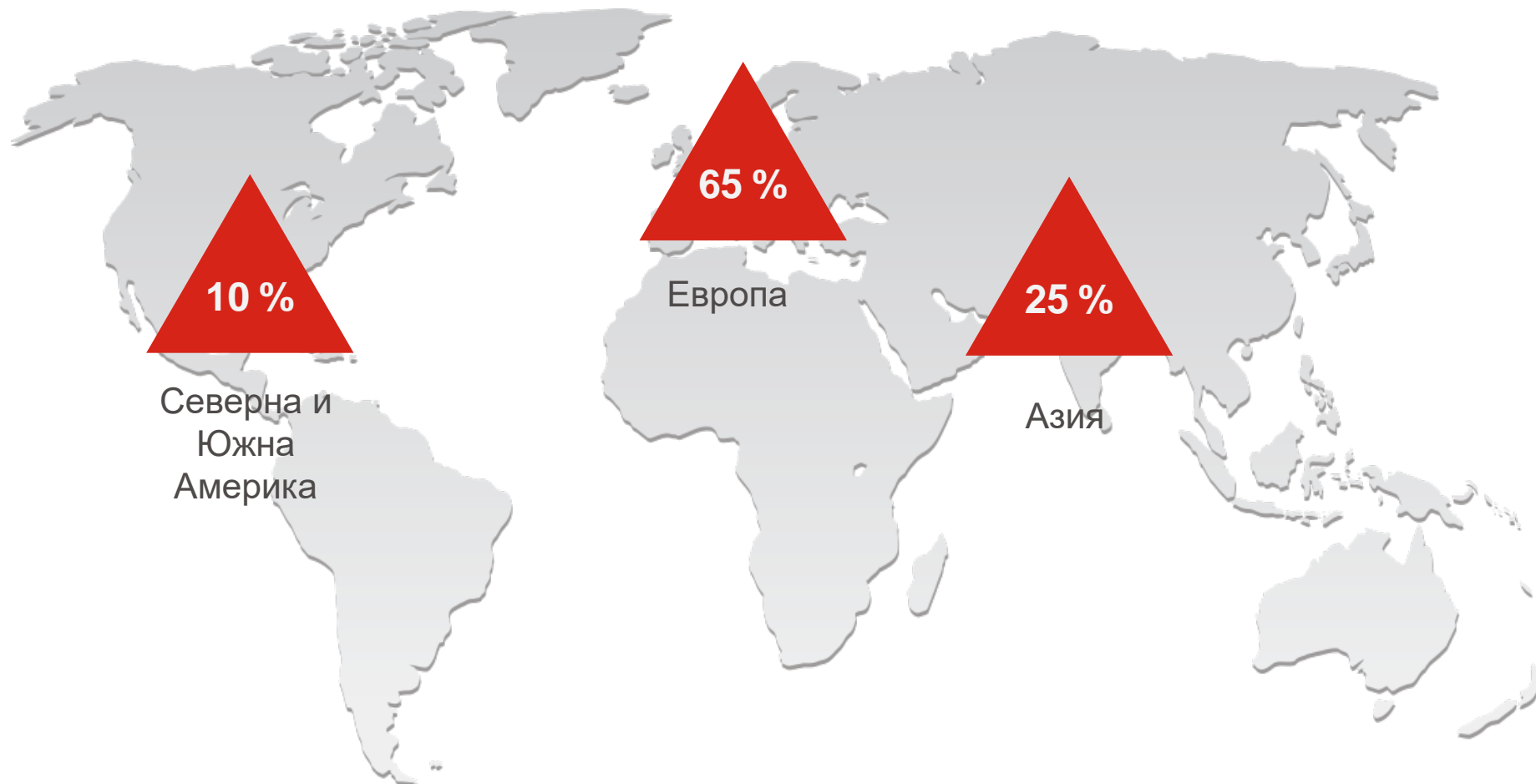

# Каква е нашата дейност?

**Твърда сплав, съставен от различни материали с уникални свойства**

- ▲ Устойчивост на износване
- ▲ Висока твърдост
- ▲ Висока издръжливост



# Страст към твърдата сплав

Композитен материал с уникални свойства



## Волфрамовкарбид

Издръжлив , твърд и  
едновременно с това жилав

# \ Ние разработваме полуготови и готови твърдосплавни продукти

За различни приложения

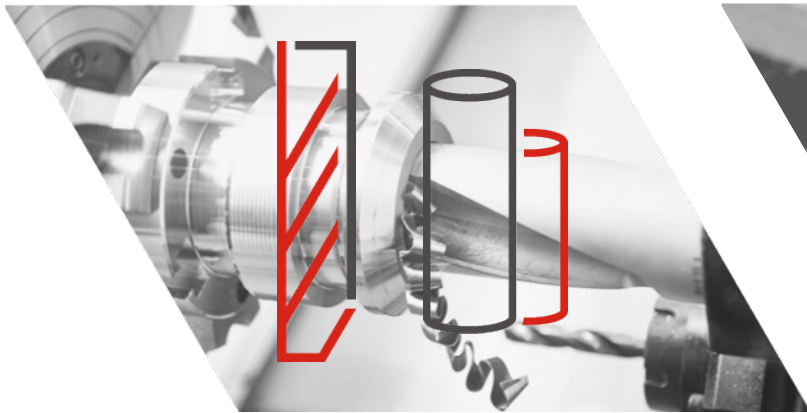

Обработка чрез стружкоотнемане

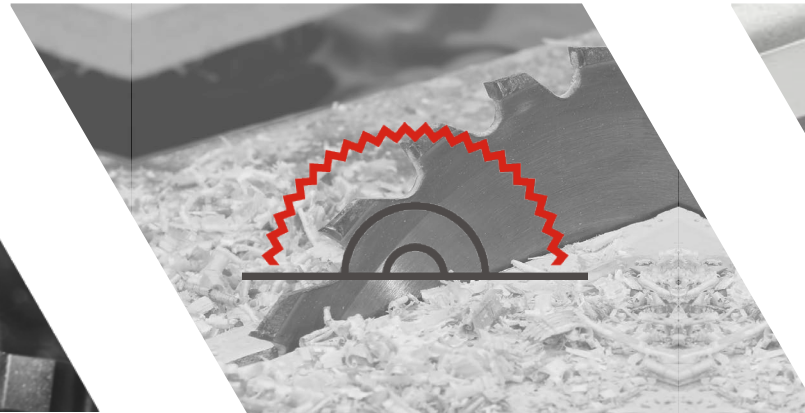

Обработка на дърво и камък

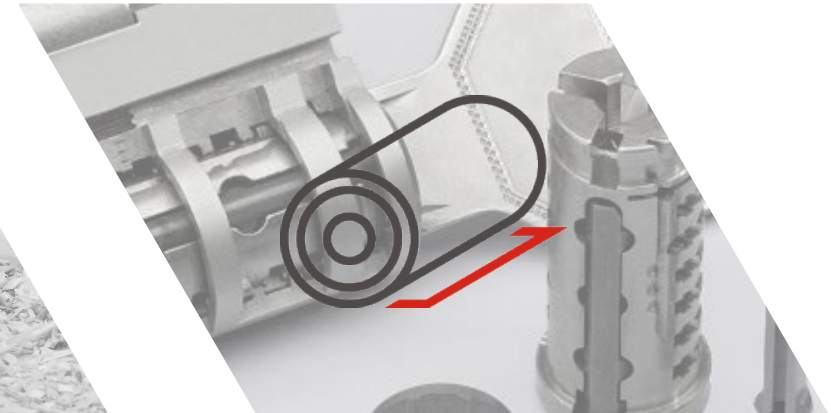

Защита от износване

# \ Ние разработваме полуготови и готови твърдосплавни продукти

За клиентски сегменти в цялата верига за създаване на стойност



Производители на инструменти



Клиенти със собствена марка



Партньори за дистрибуция



Крайни потребители



# \ Области на приложение на нашите продукти



Автомобилостроене



Машиностроене



Строителство



Медицина



Въздухоплаване



Развекателна  
електроника



Енергетика

# \ НАШИТЕ РЕШЕНИЯ ЗА АВТОМОБИЛНАТА ПРОМИШЛЕНОСТ



A photograph of a woman with dark hair in a ponytail, wearing glasses, looking out of the open window of a car. The scene is bathed in warm, golden light, suggesting a sunset or sunrise. The car's interior and window frame are visible. The background is a bright, hazy outdoor setting.

moving

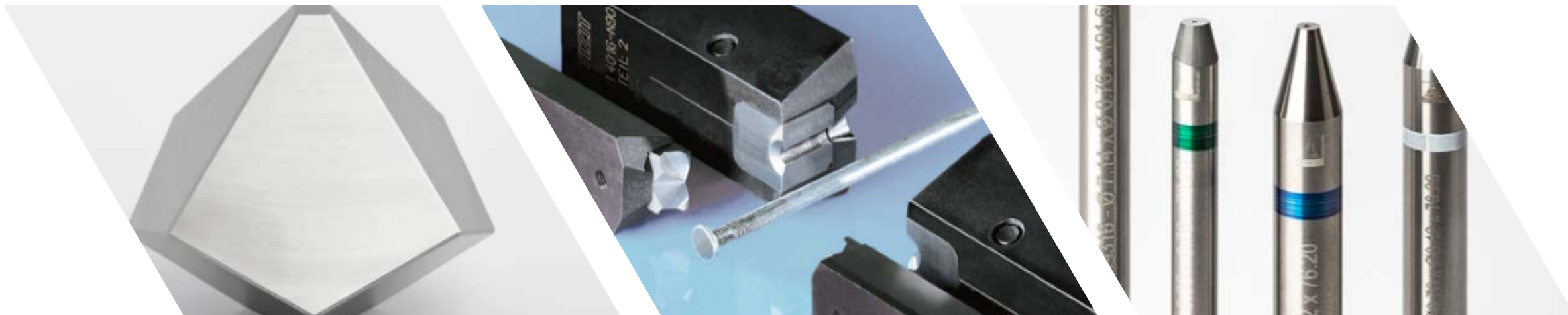



A photograph of two men in a computer lab. The man on the left, with a beard and glasses, is holding a black 3D printed part. The man on the right, also with glasses, is looking at the part. In the background, two computer monitors are visible. The left monitor shows a 3D CAD model of the part, and the right monitor shows a technical drawing of the part. The word "innovating" is overlaid in large white text across the center of the image.

# innovating





A photograph of two men in a construction setting. The man on the left wears a white hard hat and a dark blue t-shirt. The man on the right wears a yellow hard hat, a dark blue t-shirt, and an orange high-visibility safety vest with reflective grey stripes. They are both looking down at a large white sheet of paper, likely blueprints, which the man on the left is holding. The background shows a steel framework of a building under construction against a blue sky with some clouds. A red diagonal shape is in the top right corner of the image.

**building up**

# \ НАШИТЕ РЕШЕНИЯ ЗА МЕДИЦИНАТА

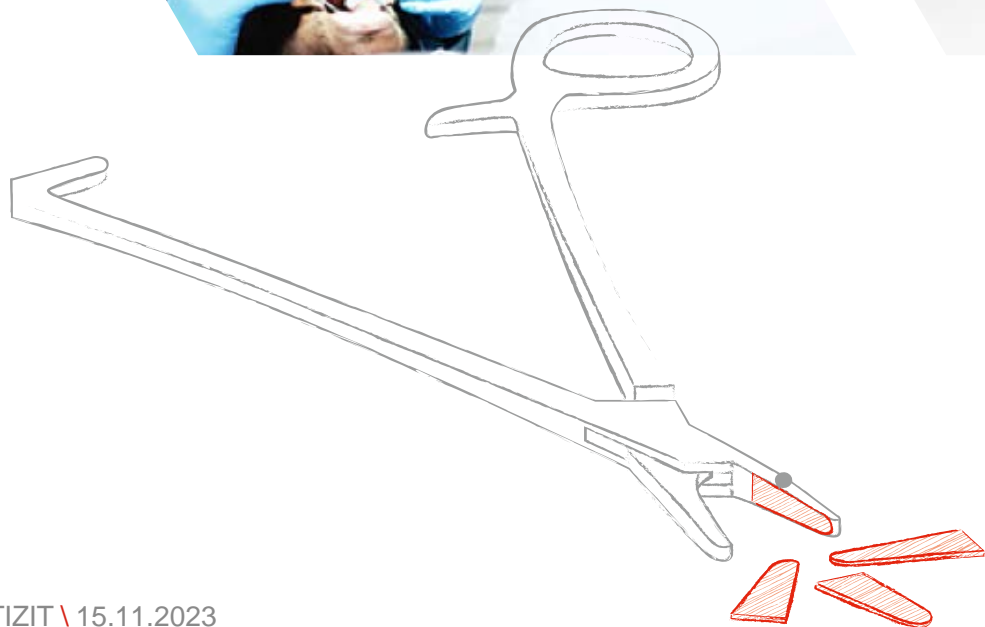



A photograph of three surgeons in an operating room, wearing blue scrubs and masks, focused on a patient. The scene is dimly lit, with the primary light source coming from the surgical lights, creating a professional and serious atmosphere. The surgeons are wearing blue bouffant caps and surgical masks. The text 'taking care' is overlaid in the center of the image in a large, white, sans-serif font.

**taking care**

# \ НАШИТЕ РЕШЕНИЯ ЗА АВИАЦИОННАТА ИНДУСТРИЯ





A photograph of a man with a beard and glasses, wearing a light blue denim shirt and tan pants, walking down the stairs of an airplane. He is carrying a brown jacket and holding a coffee cup. Other passengers are visible behind him on the stairs. The airplane's engine and tail are visible in the background.

taking off

# \ НАШИТЕ РЕШЕНИЯ ЗА ЕЛЕКТРОНИКАТА





A photograph of a woman with dark curly hair, wearing a yellow t-shirt, sitting in the driver's seat of a car. She is smiling broadly and laughing while talking on a black mobile phone held to her ear. The background shows a blurred street scene with other cars and trees. A large red triangle is in the top right corner of the image.

connecting

# \ НАШИТЕ РЕШЕНИЯ ЗА ЕНЕРГЕТИКАТА







generating

# НАЧИНЪТ, ПО КОЙТО ГО ПРАВИМ

## ПРОЦЕС

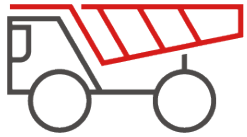

Добиване на  
материали

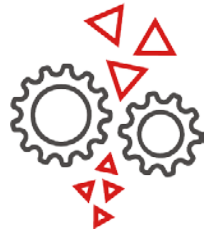

Подготовка и  
смесване на праха

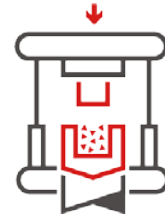

Формиране /  
Пресоване



Синтероване



Финализиране



Контрол на  
качеството



Експедиция



Рециклиране

# \ ДОПЪЛНИТЕЛНИ УСЛУГИ С ВИСОКА СТОЙНОСТ

Нанасне на покрития

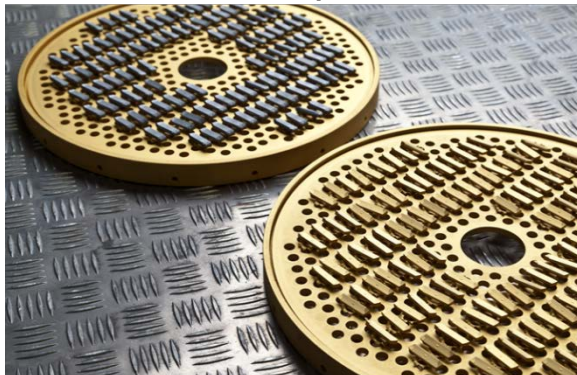

Окончателно шлифоване



Съвместни разработки и техническо  
обслужване



Иновационен център





## Висококвалифицирани екипи за разработки

- ▲ учени в областта на материалите
- ▲ химици
- ▲ машинни инженери
- ▲ инженер-коструктори
- ▲ производствени инженери
- ▲ процесинженери
- ▲ инженери по опазване на околната среда

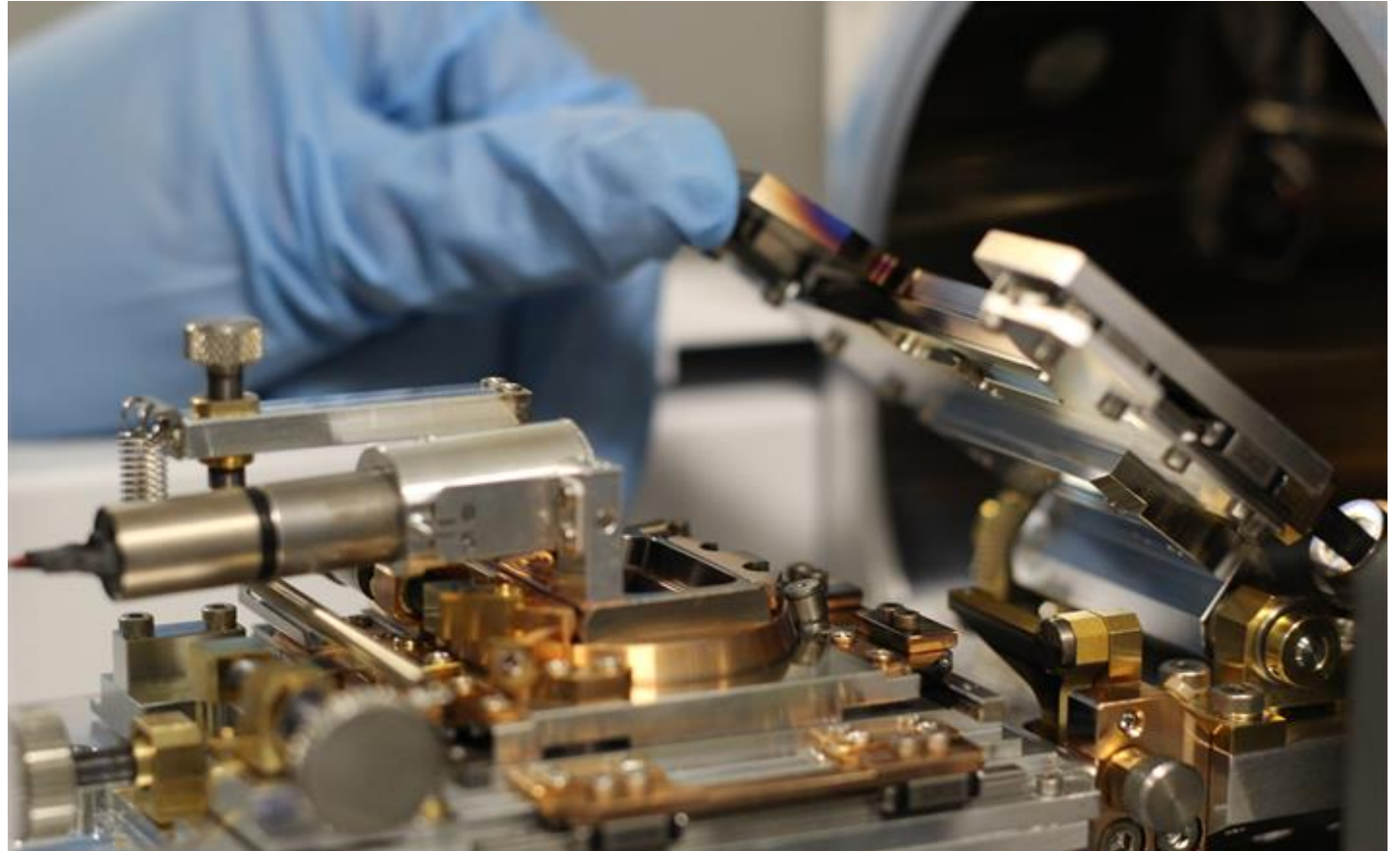

# Прогрес и ноу-хау

- ▲ Програми за съвместно развитие с иновативни клиенти
- ▲ Тясно сътрудничество с университети и изследователски центрове
- ▲ Повече от 100 години опит в областта на праховата металургия, обработката и използването на прахове

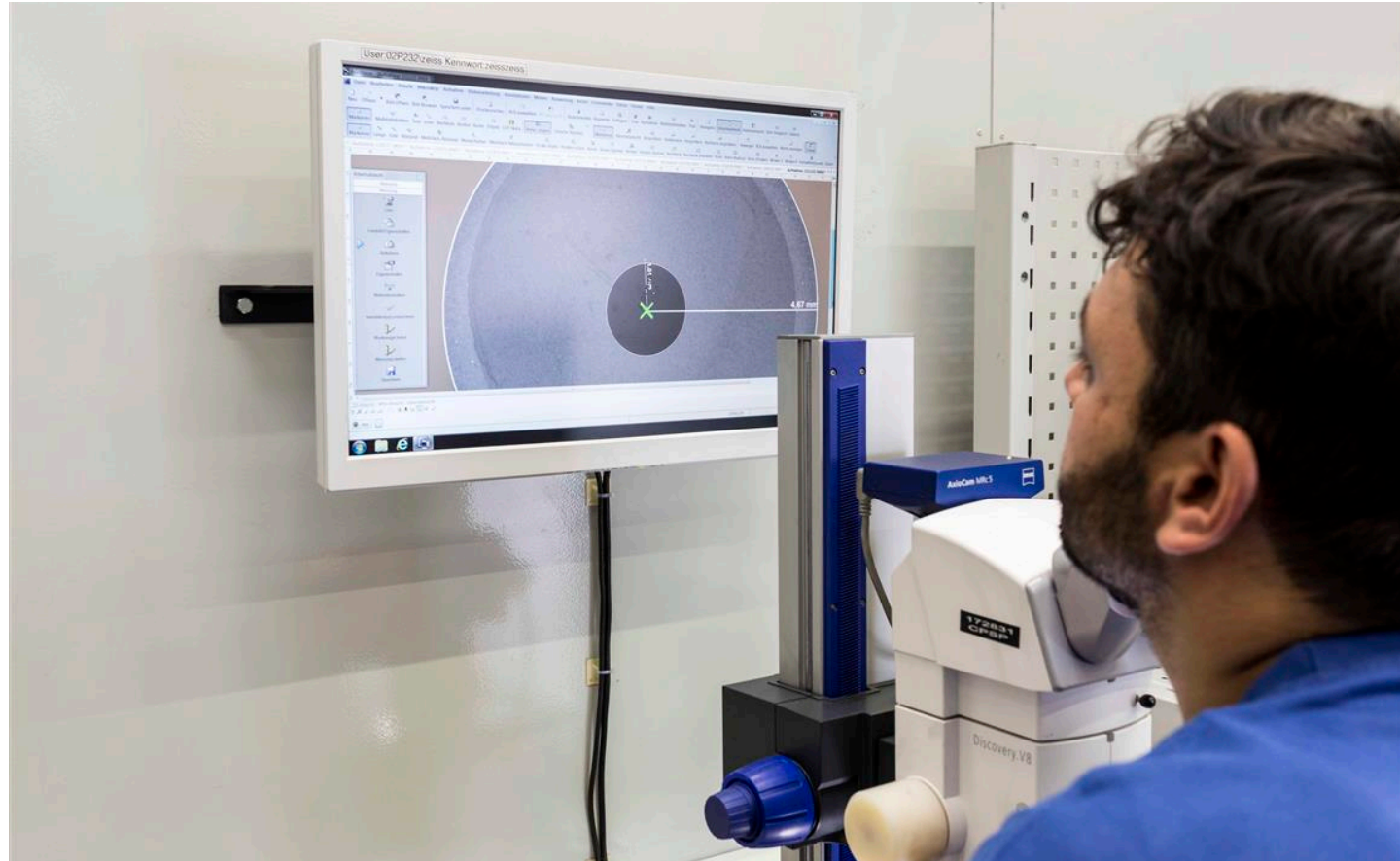

## ПАРТНЬОРИ



Специфични решения  
за клиентите



Широка гама от  
стандартни решения



E-business платформа,  
достъпна 24/7



Най-съвременен  
логистичен център

## ПАРТНЬОРИ

### Търговска мрежа по целия свят

- ▲ Отлична техническа компетентност
- ▲ Помощ при решаване комплексни въпроси
- ▲ Индивидуални консултации





## Отговорност

- ▲ Суровини без конфликтни точки
- ▲ Управление на качеството, енергията, околната среда
- ▲ Съоръжения за рециклиране





## Ориентиране към хората

- ▲ Обучителни програми от най-високо ниво
- ▲ Възможности за международна кариера
- ▲ Баланс между кариера и личен живот
- ▲ Многостранни задания
- ▲ Възможности за развитие



# ИНСТРУМЕНТИ ЗА БЪДЕЩЕТО